

Insulin keys

Sugar insulin stories – Story 2 - Girl

- 1 Your pancreas is
makes insulin

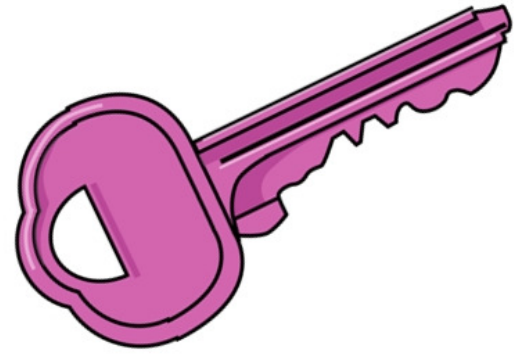
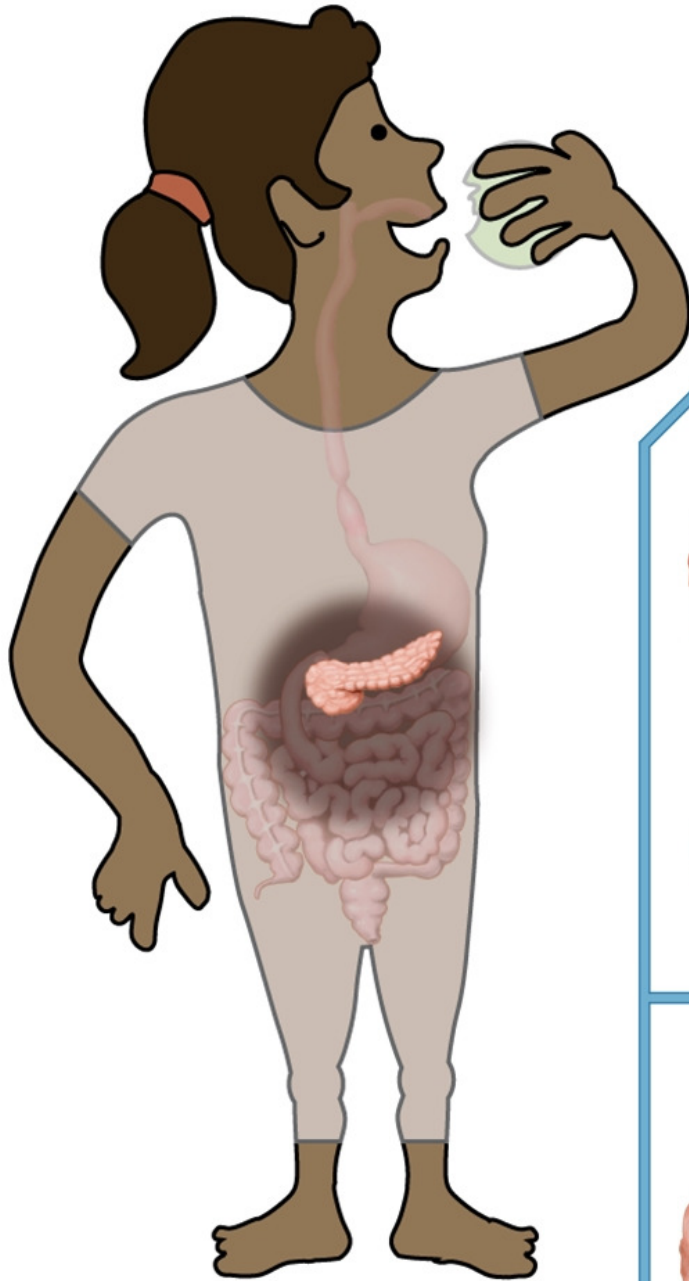

- 2 This is an insulin key

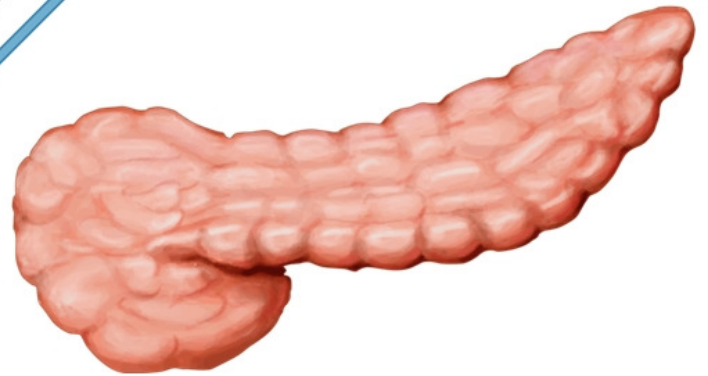

- 3 Your pancreas is near your
stomach

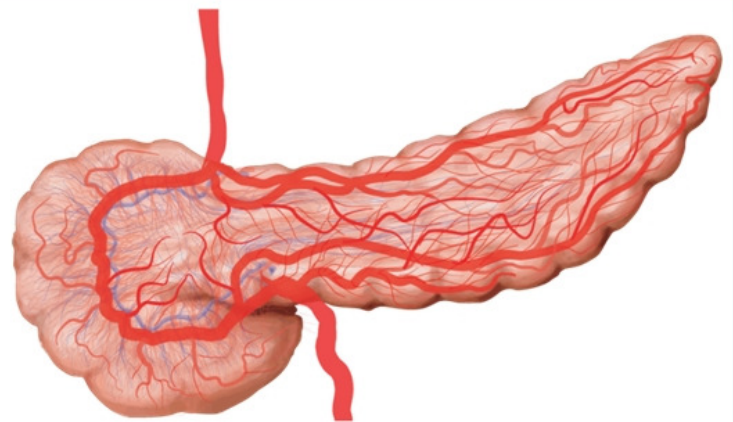

- 4 Your pancreas has lots of
blood pipes



5

Your pancreas makes insulin keys

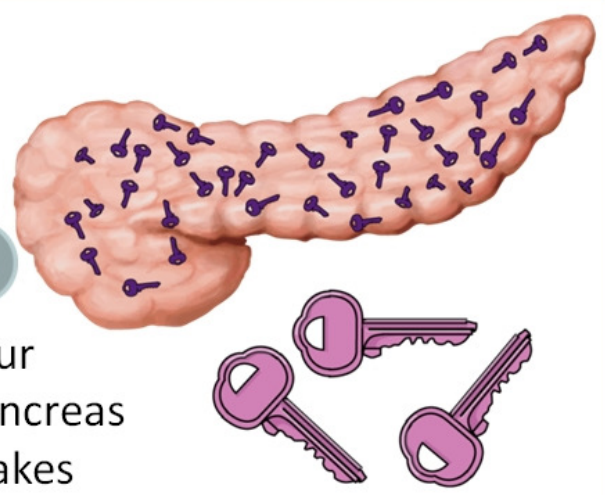

6

The insulin keys go into your blood

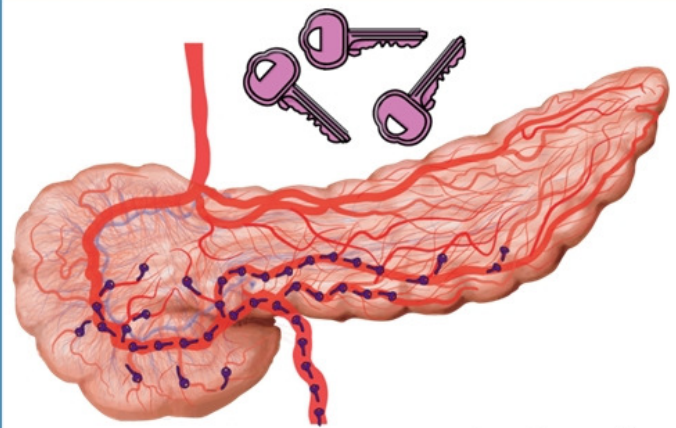

7

Insulin and sugar go around inside your blood pipes

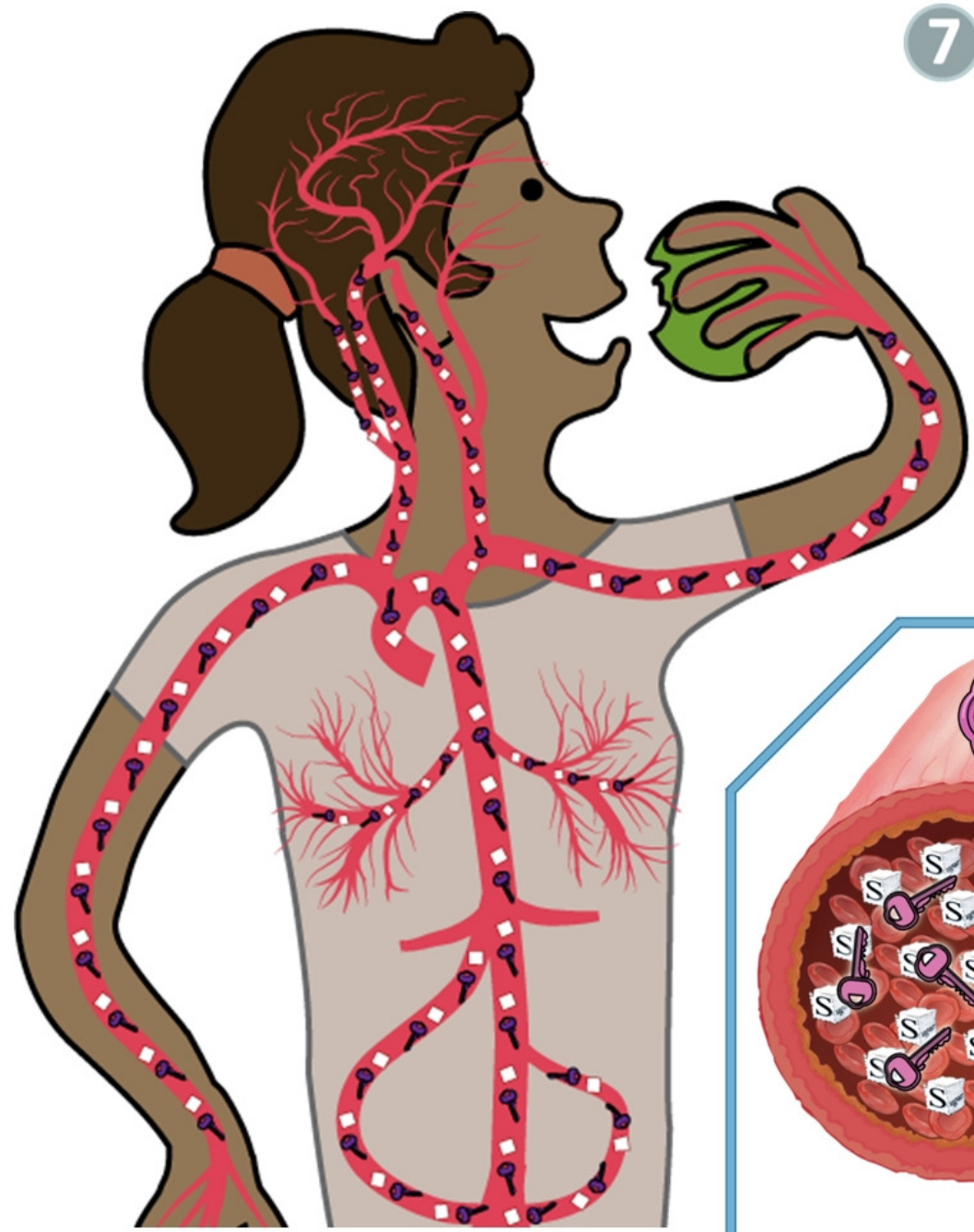

8

Insulin in your blood

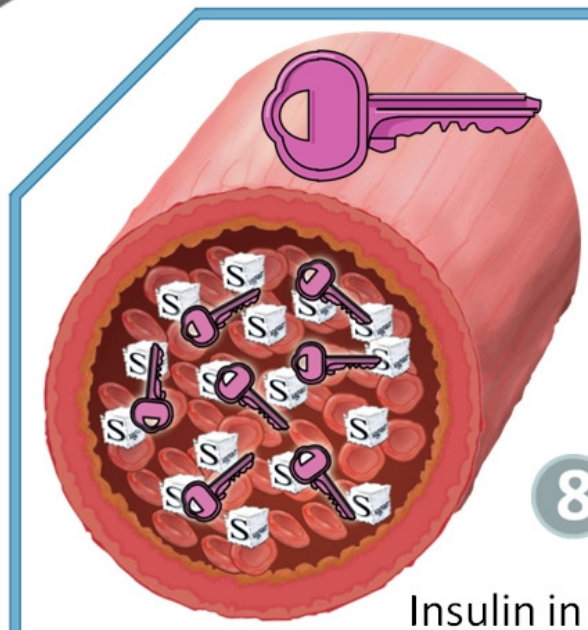



9 Insulin goes to your muscles

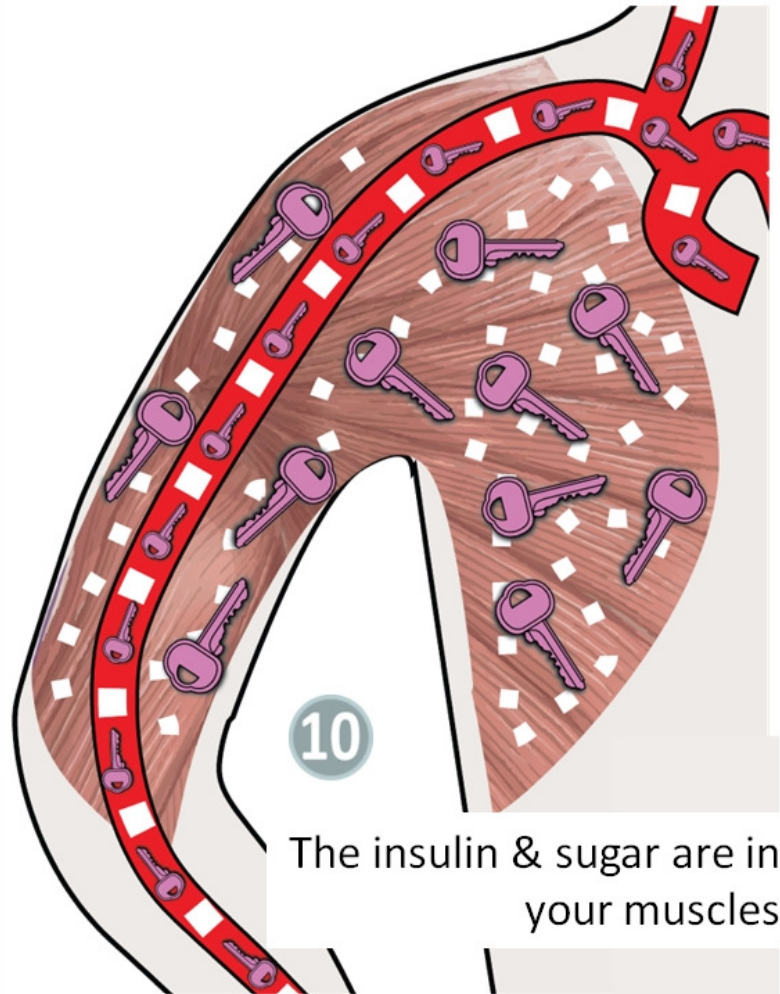

10 The insulin & sugar are in your muscles

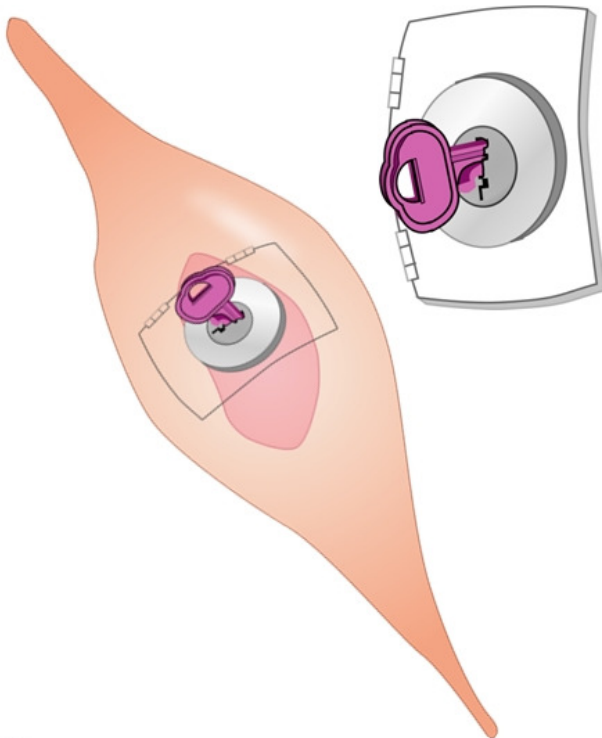

11 The insulin key unlocks the muscle cell

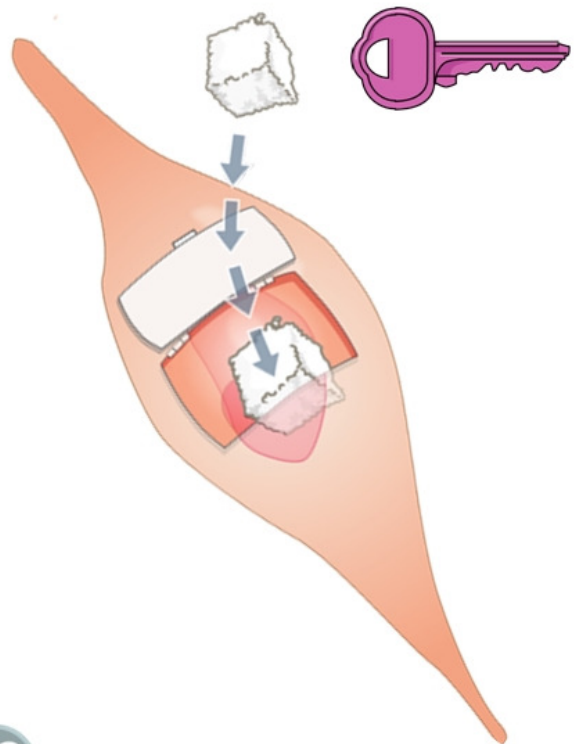

12 The sugar goes into the muscle cell

13

REMEMBER:
Your pancreas
makes insulin

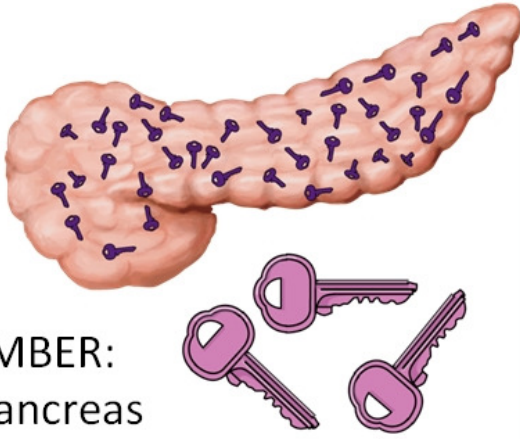

14

Your muscle cells have
an engine

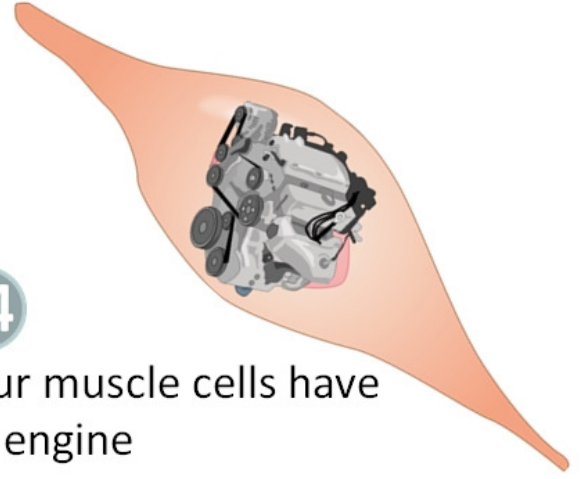

15

Sugar is your muscles fuel



16

The engine
makes the
muscle
work

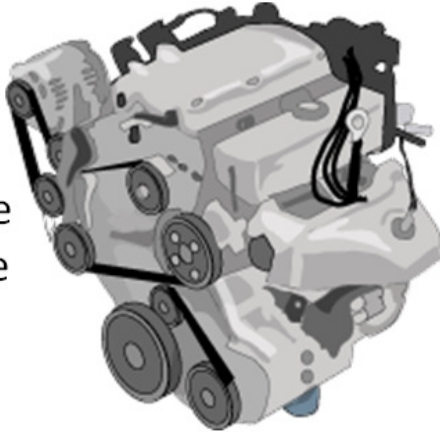

17

Sugar is
burnt is
the
engine



18

Without
insulin,
sugar
can't get
into the
muscle
cells

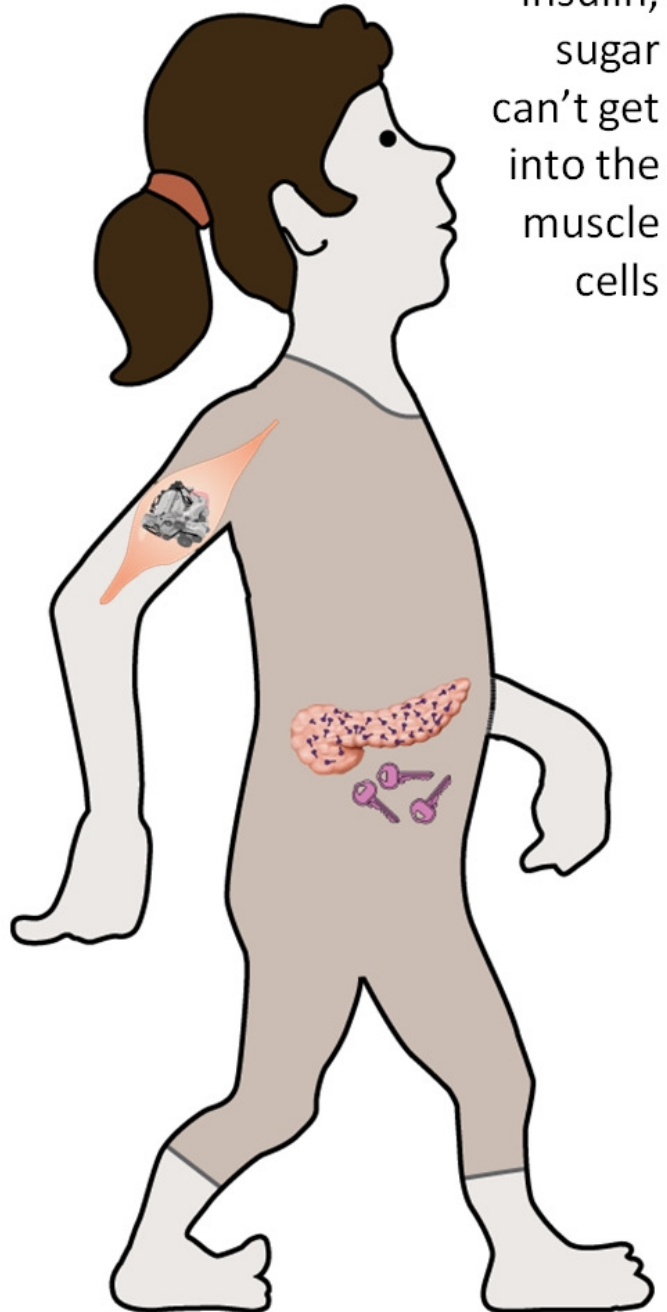

There is no need to print the following page when printing and using this resource

Health Professional Facilitator Information

You must use your own professional judgement when using this resource

Purpose of resource:

Tablet handouts for the diabetes sugar story which can be used with groups or individuals.





Area: Diabetes

Topic: Sugar insulin stories

Story: Sugar in food (Small cards)

Related resources

There are Tablet handouts for the following :

1. Sugar in food 
2. Insulin keys 
3. Insulin resistance 
4. No insulin keys (Type 1) 
5. Not enough insulin keys (Type 2) 

Notes:

The resource can be printed A3 or A4 size and then laminated.

This version of the resource can only be obtained from the Chronic Disease website and is licensed and distributed using the Australia – Personal Licence -A0-6/2015

Levels

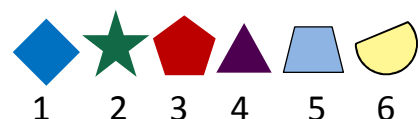

Full Licence Terms

Auz.it Australia – Health Purpose - Personal Licence – June 2015. Licence reference: AHP-A0-6/2015

Licence Terms

THE TERMS OF THIS LICENCE ARE A MODIFICATION OF THE CREATIVE COMMONS ATTRIBUTION-NONCOMMERCIAL-NODERIVS 3.0 AUSTRALIA LICENSE LEGAL CODE (CC BY-NC-ND 3.0). THE CREATIVE COMMONS LICENSE TERMS ARE LICENSED UNDER A CREATIVE COMMONS ATTRIBUTION 3.0 LICENSE, <http://creativecommons.org/licenses/by/3.0/> AND THE CREATIVE COMMONS COPYRIGHT NOTICE AND LICENSING INFORMATION ARE AVAILABLE FROM THAT WEBSITE. FOR THE AVOIDANCE OF DOUBT, AUZ.IT AUSTRALIA DOES NOT AS OF IMPLY ANY CONNECTION WITH, SPONSORSHIP OR ENDORSEMENT BY CREATIVE COMMONS.

Licence

THE WORK (AS DEFINED BELOW) IS PROVIDED UNDER THE TERMS OF THIS HEALTH PURPOSE LICENCE ("LICENCE"). THE WORK IS PROTECTED BY COPYRIGHT AND/OR OTHER APPLICABLE LAW. ANY USE OF THE WORK OTHER THAN AS AUTHORISED UNDER THIS LIC OR COPYRIGHT LAW IS PROHIBITED.

BY EXERCISING ANY RIGHTS TO THE WORK PROVIDED HERE, YOU ACCEPT AND AGREE TO BE BOUND BY THE TERMS OF THIS LICENCE LICENSOR GRANTS YOU THE RIGHTS CONTAINED HERE IN CONSIDERATION OF YOUR ACCEPTANCE OF SUCH TERMS AND CONDITIONS

1. Definitions

- a. **"Health Purpose"** means to produce and deliver training materials and training services on a non-Commercial basis, in connection with:
 - a. health promotion;
 - b. research;
 - c. clinical practice in health;
 - d. health education; or
 - e. health training.
- b. **"Collection"** means the Work in its entirety in unmodified form along with one or more other separate and independent works, assembled into a collective who Collection may, for example, include a periodical, encyclopaedia or anthology.
- c. **"Commercial"** means primarily intended for or directed towards commercial advantage or private monetary compensation. The exchange of the Work for other copyright works by means of digital file-sharing or otherwise shall not be considered to be Commercial, provided there is no payment of any monetary compensation with the exchange of copyright works.
- d. **"Derivative Work"** means material in any form that is created by editing, modifying or adapting the Work, a substantial part of the Work, or the Work and other existing works. Derivative Works may, for example, include a translation, adaptation, musical arrangement, dramatisation, motion picture version, sound record reproduction, abridgment, condensation, or any other form in which the Work may be transformed or adapted, except that a Collection will not be considered a Derivative Work for the purpose of this Licence. For the avoidance of doubt, where the Work is a musical composition or sound recording, the synchronization Work in timed-relation with a moving image ("synching") will be considered a Derivative Work for the purpose of this Licence.
- e. **"Distribute"** means to make available to the public by any means, including publication, electronic communication, or broadcast.
- f. **"Licensor"** means the individual, individuals, entity or entities that offer(s) the Work under the terms of this Licence.
- g. **"Reproduce"** means to make a copy of the Work in any material form (eg storage in digital form).
- h. **"Work"** means the material (including any work or other subject matter) protected by copyright which is offered under the terms of this Licence. This may include (without limitation) a literary, dramatic, musical or artistic work; a sound recording or cinematograph film; a published edition of a literary, dramatic, musical or work; or a television or sound broadcast.
- i. **"Educational Resource"** means a publication or animation which is used for a Health Purpose.
- j. **"Artwork"** means a Work which is an illustration, photograph, or other non-textual material which has been prepared for inclusion in an Educational Resource.
- k. **"Organisation"** means a Corporation, Government, Non-governmental organisation, International organisation, Armed forces, Charity, Not-for-profit Corpora Partnership, Cooperative, or University.
- l. **"Expiry date"** means the expiry date displayed on the Work, or in the case where there is no Expiry Date displayed on the Work, the expiry date is 2 years from time you obtain the Work on an Auz.it Australia CDRO website. (<http://www.cdoro.com.au>).
- m. **"New Resource"** means an Educational Resource which includes "Artwork" licensed under this licence. A New Resource does not have an Expiry Date.
- n. **"Non-Modifiable Format"** means an electronic format where the Artwork can be easily extracted and used in a New Resource.
- o. **"PDF File"** means a Portable Document Format file format used to represent documents in a manner independent of application software, hardware, and operating system.
- p. **"You"** means an individual or entity exercising rights under this Licence who has not previously violated the terms of this Licence with respect to the Work, or received express permission from the Licensor to exercise rights under this Licence despite a previous violation.
- q. **"Personal Use"** means use for Health Purposes by You, provided You are not an Organisation or working under instructions to use the Work from an Organisation.

2. Fair Dealing and Other Rights

Nothing in this Licence is intended to reduce, limit, or restrict any uses free from copyright or rights arising from limitations or exceptions under copyright law or any other applicable laws.

3. Licence Grant

3A Grant of Rights

Provided that the terms set out in this Licence are satisfied, the Licensor grants to You a royalty-free, non-exclusive licence to exercise the following rights for the Health Purpose

- a. You may use the Work for a Health Purpose.
- b. You may make 1 (one) electronic copy of the Work for back up purposes. You have no rights to distribute the Work, in any other electronic communication, in any public website or email.
- c. You may only make a total of 10 printed copies (including photocopies) of the Work.
- d. You cannot use the Work after the Expiry date. If you wish to continue to use the Work you must download a new copy of the Work with a new licence from an Auz.it Australia CDRO website (<http://www.cdoro.com.au>).

3B Media, Formats and No Derivative Works

The above rights may be exercised in any media or format whether now known or hereafter created. They include the right to make modifications that are technically necessary to exercise the rights in other media and formats. Other than such technical modifications, You have no rights to make Derivative Works.

3C Other Rights Reserved

All rights not expressly granted by the Licensor are reserved. This includes the right to collect royalties, whether individually or via a licensing body such as a collecting society, for any Commercial use of the Work. The Licensor waives the right to collect royalties for any exercise by You of the rights granted under this Licence.

4. Restrictions

The licence granted above is limited by the following restrictions.

4A Restrictions on Distribution and Public Performance of the Work

You may not Distribute the work in any form or publicly perform the Work under the terms of this Licence.

4B Restrictions on Commercial Use

You may not exercise any of the rights granted to You by clause 3 or clause 4A above in any Commercial manner.

4C Moral Rights

Moral rights remain unaffected to the extent they are recognised and nonwaivable at law. In this clause 4D, "moral rights" means the personal rights granted by law to the Original Author of a copyright work. For example, Part IX of the *Copyright Act 1968* (Cth) grants authors the right of integrity of authorship, the right of attribution of authorship, and the right not to have authorship falsely attributed.

4D Use in a Collection

You may not include the Work in a Collection.

5. Representations, Warranties and Disclaimer

- a. Except as expressly stated in this Licence or otherwise agreed to by the parties in writing, and to the full extent permitted by applicable law, the Licensor offers the Work "as-is" and makes no representations, warranties or conditions of any kind concerning the Work, express, implied, statutory or otherwise. This includes, without limitation, any representations, warranties or conditions regarding:
 - i. the contents or accuracy of the Work;
 - ii. title, merchantability, or fitness for a particular purpose;
 - iii. non-infringement;
 - iv. the absence of latent or other defects; or
 - v. the presence or absence of errors, whether or not discoverable.
- b. The *Competition and Consumer Act 2010* (Cth), and the corresponding State and Territory fair trading legislation, imply certain warranties and conditions in certain circumstances, such as the right to supply or fitness for purpose of goods or services supplied to a consumer. Clause 5(a) cannot and is not intended to exclude, restrict or modify these warranties.

6. Limit of Liability

- a. To the full extent permitted by applicable law, and except for any liability arising from contrary agreement, in no event will the Licensor be liable to You on any legal basis (including without limitation, negligence) for any loss or damage whatsoever, including (without limitation):
 - i. loss of production or operation time, loss, damage or corruption of data or records; or
 - ii. loss of anticipated savings, opportunity, revenue, profit or goodwill, or other economic loss; or
 - iii. any special, incidental, consequential, punitive or exemplary damages arising out of or in connection with this Licence or the use of the Work, even if the Licensor has been advised of the possibility of such damages.
- b. If applicable legislation implies warranties or conditions, or imposes obligations or liability on the Licensor in respect of this Licence that cannot be wholly or partly excluded, restricted or modified, the Licensor's liability is limited, to the full extent permitted by the applicable legislation, at its option, to:
 - i. in the case of goods, any one or more of the following:
 - the replacement of the goods or the supply of equivalent goods;
 - the repair of the goods;
 - the payment of the cost of replacing the goods or of acquiring equivalent goods;
 - the payment of the cost of having the goods repaired; or
 - ii. in the case of services:
 - the supplying of the services again; or
 - the payment of the cost of having the services supplied again.
- c. The *Competition and Consumer Act 2010* (Cth), and the corresponding State and Territory fair trading legislation, restrict the limitation of liability in certain circumstances, such as a contract for the supply of goods or services of a kind ordinarily acquired for personal, domestic, or household use. Clauses 6(a) and 6(b) cannot and are not intended to apply in circumstances where it is prohibited by law.

7. Termination

This Licence and the rights granted to You under this Licence shall terminate automatically upon any breach by You of the terms of the Licence. Individuals or entities who have received a Collection from You pursuant to this Licence, however, will not have their licences terminated provided they remain in full compliance with those licences. Clauses 1, 2, 5, 6, 7, 8, 9, 10, 11, 12 and 13 shall survive any termination of this Licence.

8. Licensor's Rights Retained

Subject to the above terms, the Licence granted here is perpetual (for the duration of the applicable copyright in the Work). Notwithstanding this, the Licensor reserves the right to release the Work under different licence terms or to stop distributing the Work at any time. However, any such release will not serve to withdraw this Licence (or any other licence that has been granted under the terms of this Licence), and this Licence will continue in full force and effect unless terminated as stated above.

9. Licence Grant to Recipients of the Work

Licensor offers the recipient a licence to the Work it is under the same terms granted under this Licence.

10. Severability

If any provision of this Licence is invalid or unenforceable under applicable law, it shall not affect the validity or enforceability of the remainder of the terms of this Licence. Without further action by the parties to this agreement, such provision shall be reformed to the minimum extent necessary to make such provision valid and enforceable.

11. Waivers and Consents

No term of this Licence shall be deemed waived and no breach consented to unless such waiver or consent is in writing and signed by the relevant party.

12. Entire Agreement

This Licence constitutes the entire agreement between the parties. To the full extent permitted by law, there are no understandings, agreements or representations with respect to the Work not specified here. The Licensor shall not be bound by any additional provisions that may appear in any communication from You. This Licence may not be modified without the written agreement of the Licensor and You.

13. Governing Law

The construction, validity and performance of this Licence shall be governed by the laws in force in Queensland, Australia.